

Green Pin® Lifting Eye UNC GR8
 Group : ALUNC
 Part : GPAL45UNC
 WLL : 15t

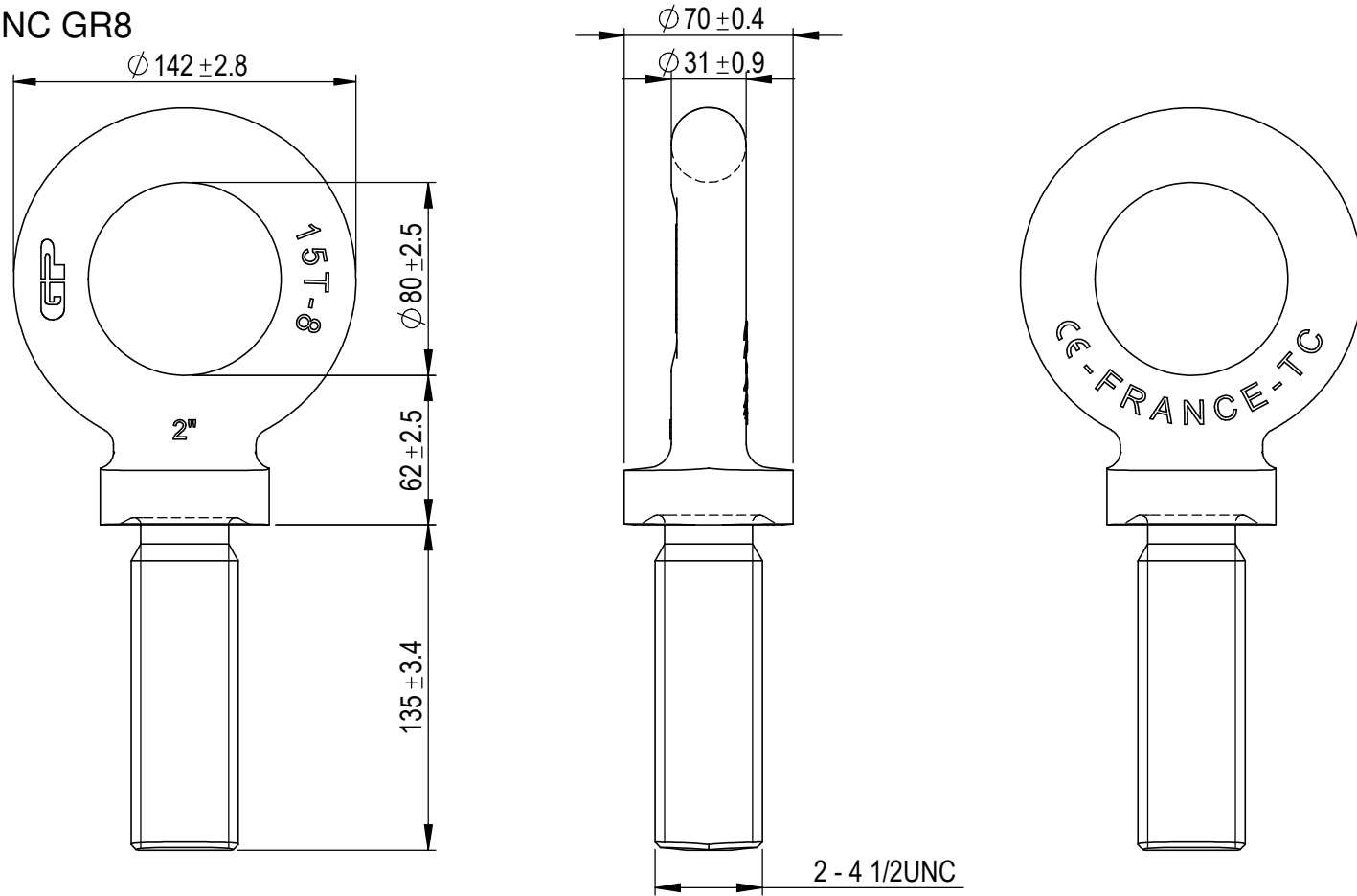

0	First Issue	2021-05-05	R.CH
Rev.	Description	Date	Drawn
Copyright by Van Beest B.V. moreover this document is the property of Van Beest B.V. This document or any part of it may neither be made known, copied or multiplied, nor used for any purpose other than that for which it is specifically furnished, without the prior written consent of Van Beest B.V.			
Title Green Pin® Lifting Eye UNC GR8		Remark ALUNC GPAL45UNC	



Green Pin®
 P.O. Box 57, 3360 AB Sliedrecht (The Netherlands)
 Industrieweg 6, 3361 HJ Sliedrecht
 Tel. +31(0)184-413300 www.greenpin.com

Format	A4	
Scale	1:3	
Drawing number	7661	Rev.
		0

We reserve the right to make amendments on specifications in this drawing without prior notification.